

Age Dependent Effects of RF Electromagnetic Fields on the Base of Relevant Biological Parameters

Andreas Christ, Marie-Christine Gosselin,
Manuel Murbach, Sven Kühn, Marcel Zefferer,
Katharina Honegger, Sonja Negovetic, and Niels Kuster

Contents

- objectives
- numerical models and methods
- age dependent parameter ranges
- computational results
- experimental setups and first results
- next steps

Objectives

- development of three high-resolution head models of children (3-11 years) and an adult with accurate segmentation of small brain regions (hypothalamus, hippocampus, bone marrow, etc.)
- simulation of the exposure of these brain regions exposed to different designs of mobile phones considering age dependent tissue parameters
- numerical assessment of the temperature increase during mobile phone exposure considering uncertainties of the thermal parameters and possible thermoregulatory effects
- experimental validation of the EM-energy absorption and temperature increase in adults and children using specially designed measurement protocols

Anatomical Models - Visible Human

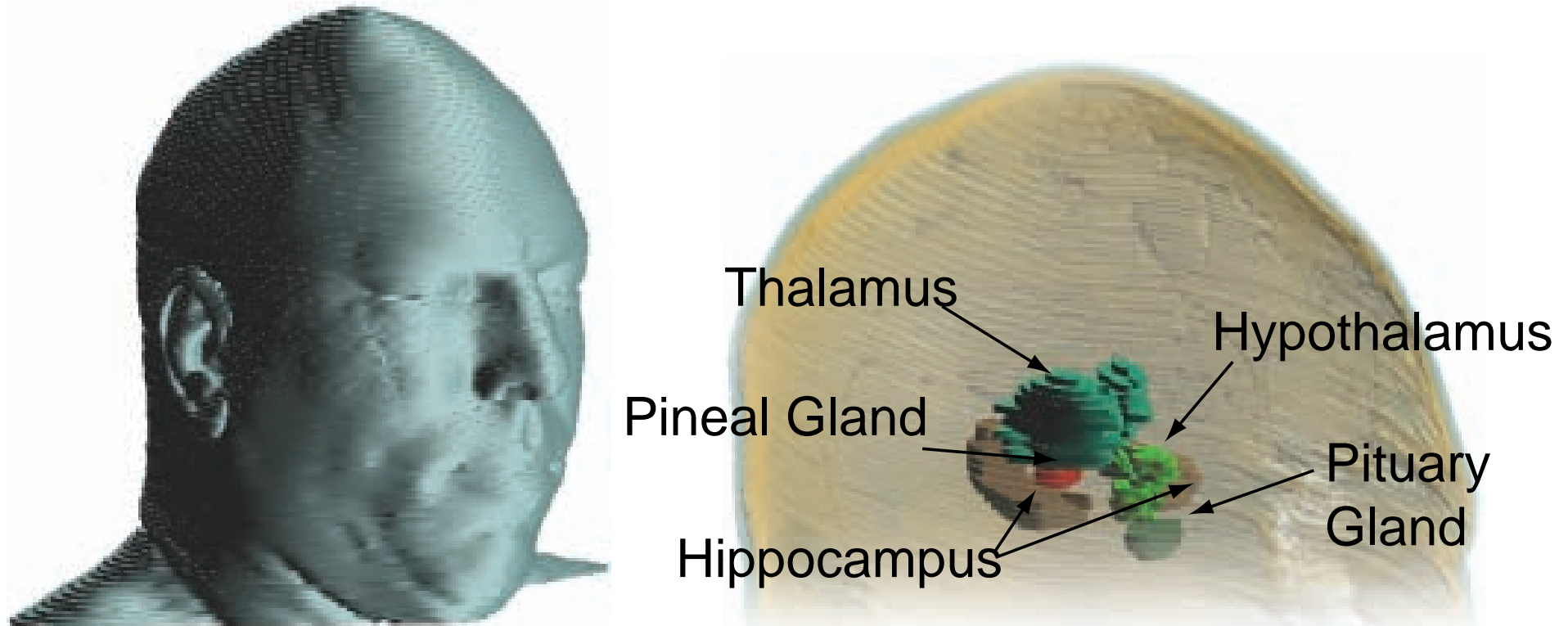

- resegmentation of cryosection images of a 38 year old male (Visible Human)
- 2.5-D model (SEMCAD Compound format) retaining the original information of the images (discretization at arbitrary resolutions)

Anatomical Models - 3 Year Old Child

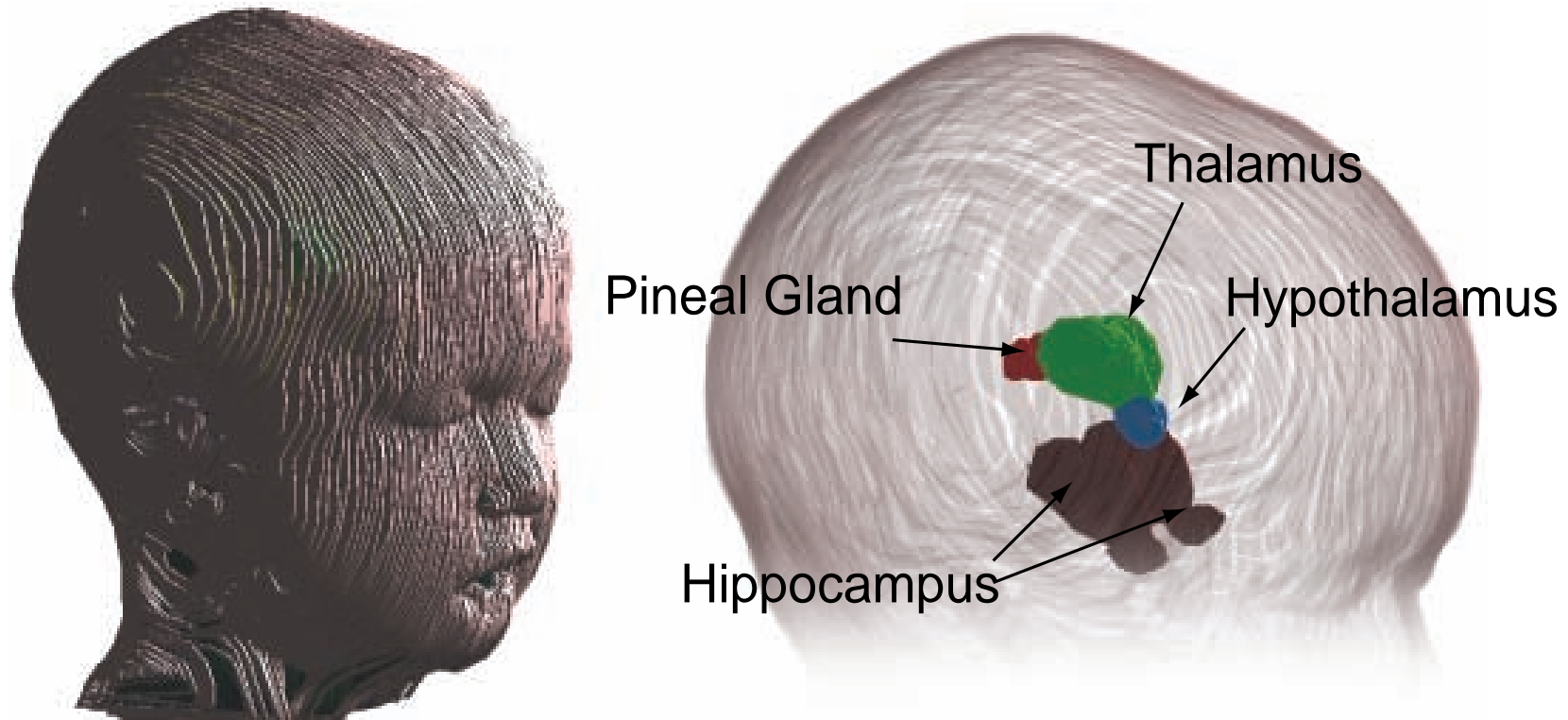

- resegmentation of MRI images of a 3 year old child
- 2.5-D model (SEMCAD Compound format) retaining the original information of the images (discretization at arbitrary resolutions)

Children's Heads of the Virtual Family Project

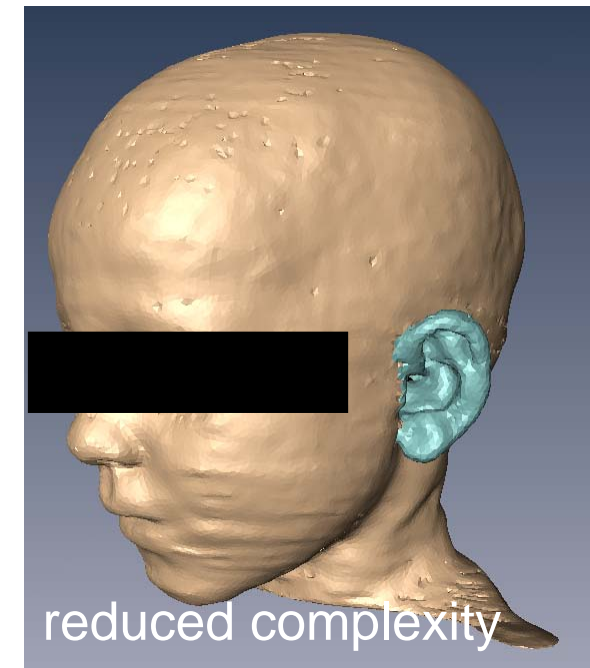
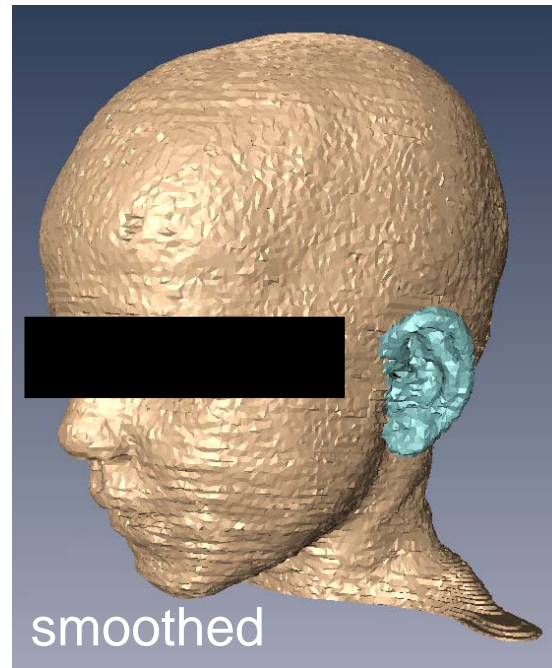
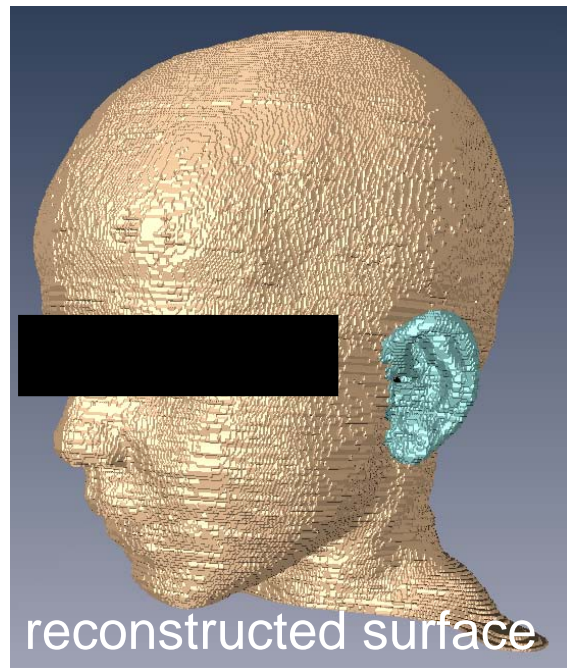

- high resolution MRI scans high ($0.5 \times 0.5 \times 1.0\text{mm}^3$ in the head)
- manual segmentation supported by a software developed in house
- surface reconstruction (marching cube), surface smoothing (spring model), reduction of complexity (triangle collapse)
- 84 different tissue types (CAD objects)
- export of organs and tissues as watertight CAD parts in SAT format

Reconstructed Head of the Boy Model

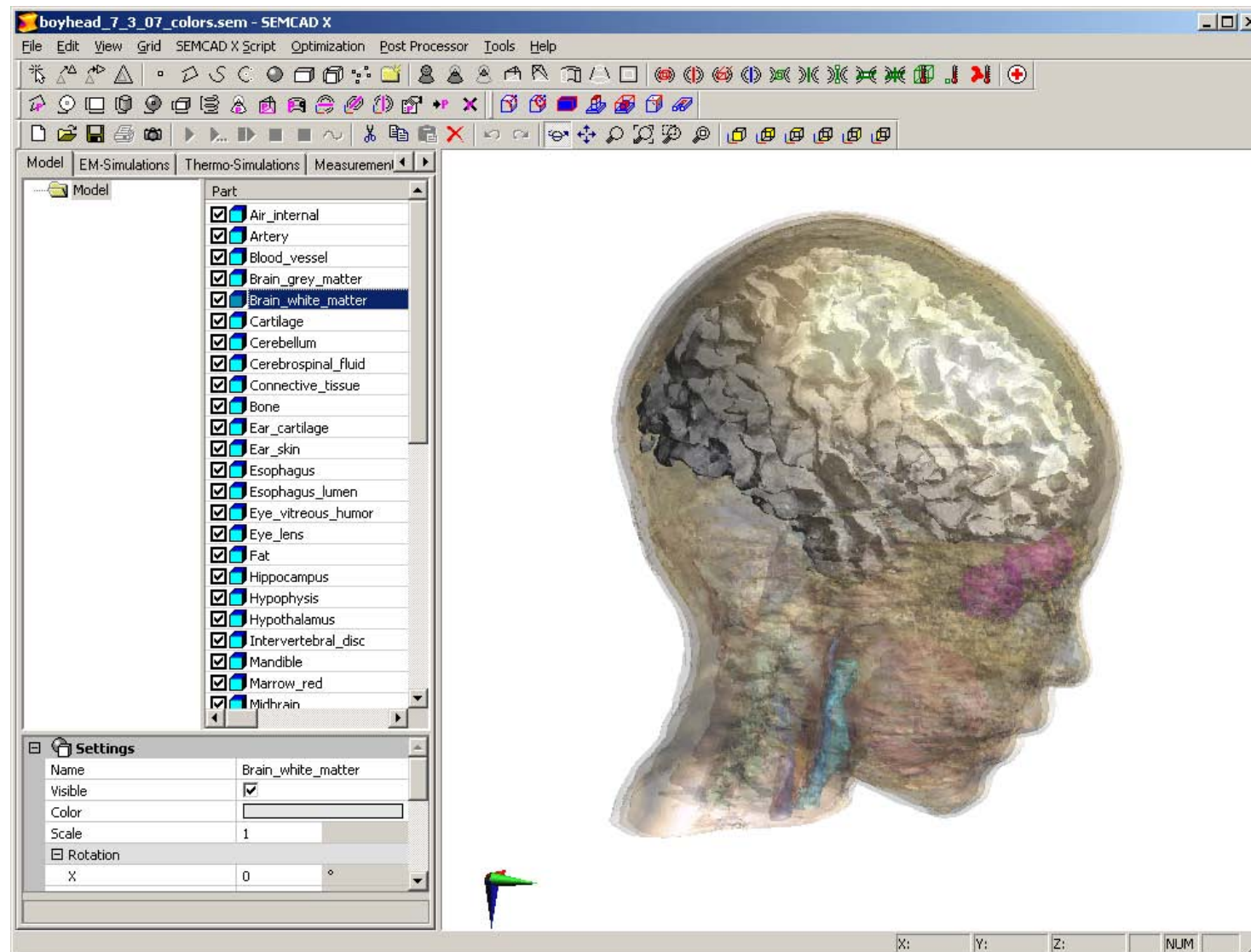

Anatomical Models - 6 Year Old Boy

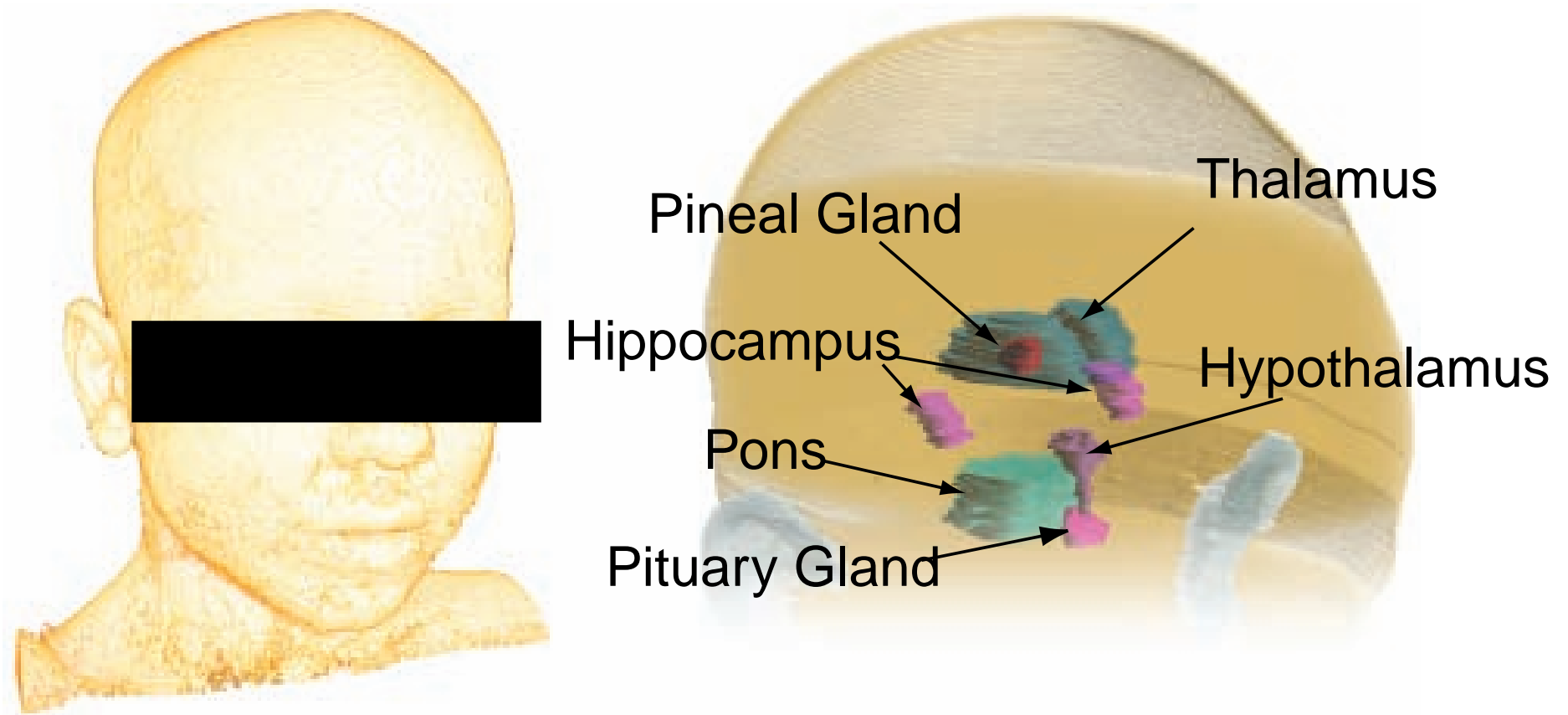

- 6 year old boy, 17kg, 1.07m, BMI 14.8

Anatomical Models - 11 Year Old Girl

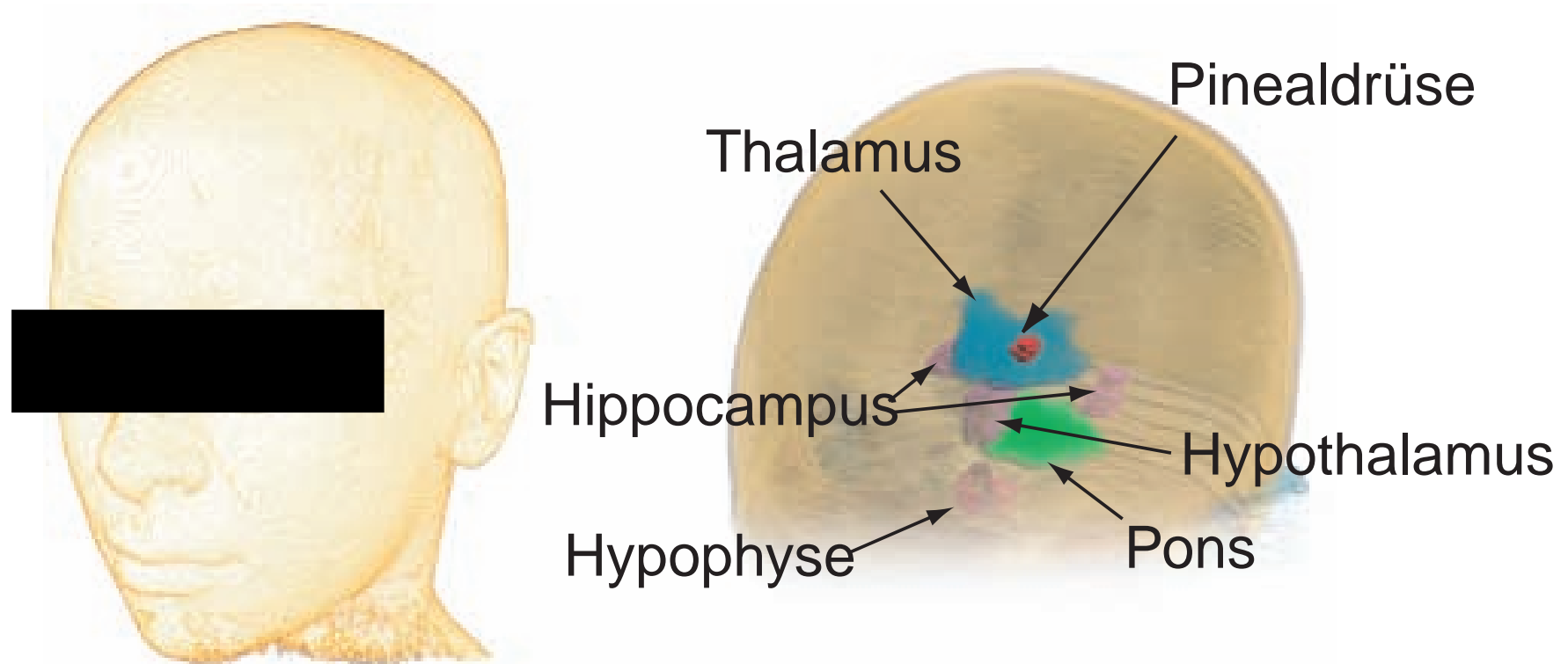

- 11 year old girl, 43kg, 1.48m, BMI 15.5

Mobile Phone Models

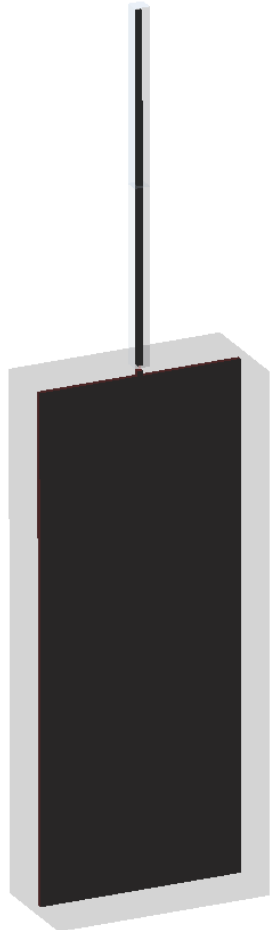

generic phone
monopole
antenna

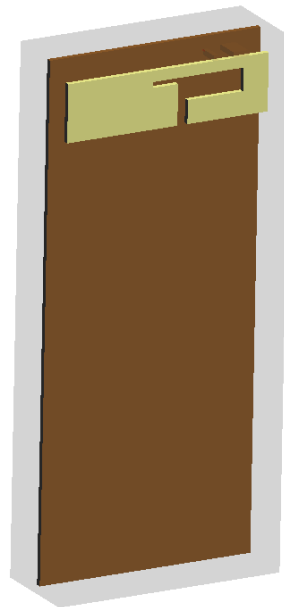

generic phone
dual band patch
antenna



Motorola
TimePort T250
helical antenna

- generic phone with monopole antenna from FDA intercomparison [Beard et al., 2006]
- generic phone with integrated dual band antenna [IEEE 1528.1, 2008]
- CAD model of Motorola Time Port T250 with helical antenna, validated in [Chavannes et al., 2003]

Validation of the Generic Phone Model

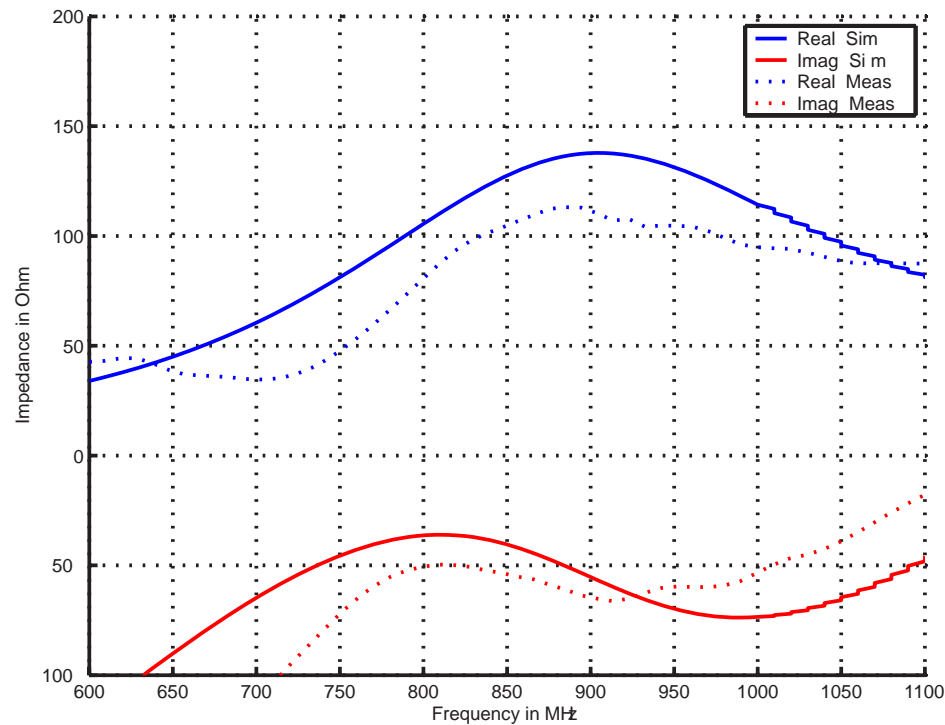

Free Space Input Impedance



manufactured
generic phone

Measurement and Simulation Setup - Cheek Position



Measurement Setup

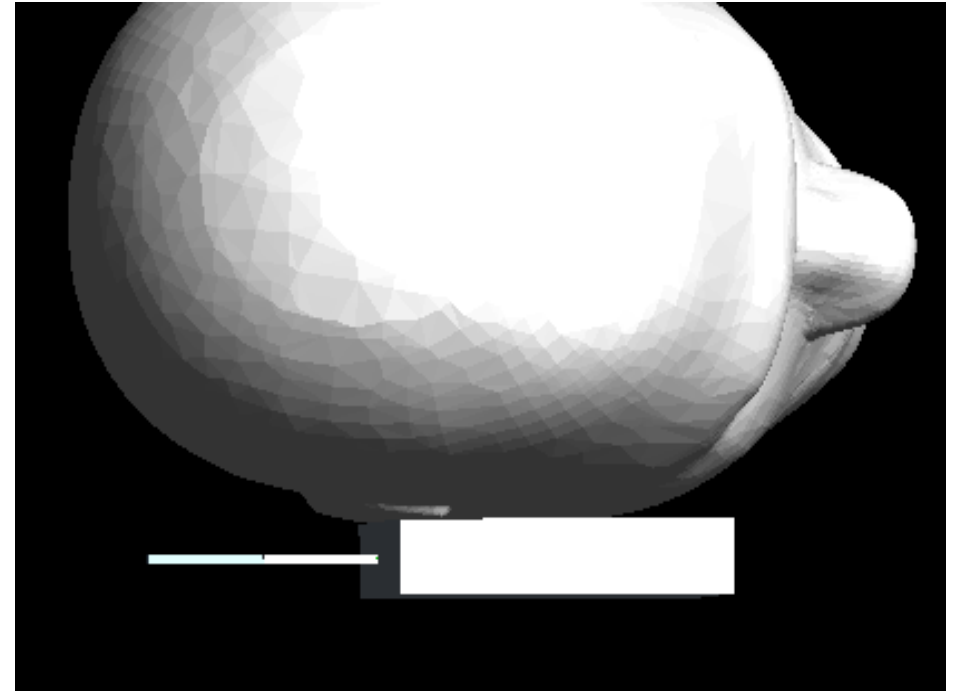

Numerical Model

SAR Distribution at 835MHz

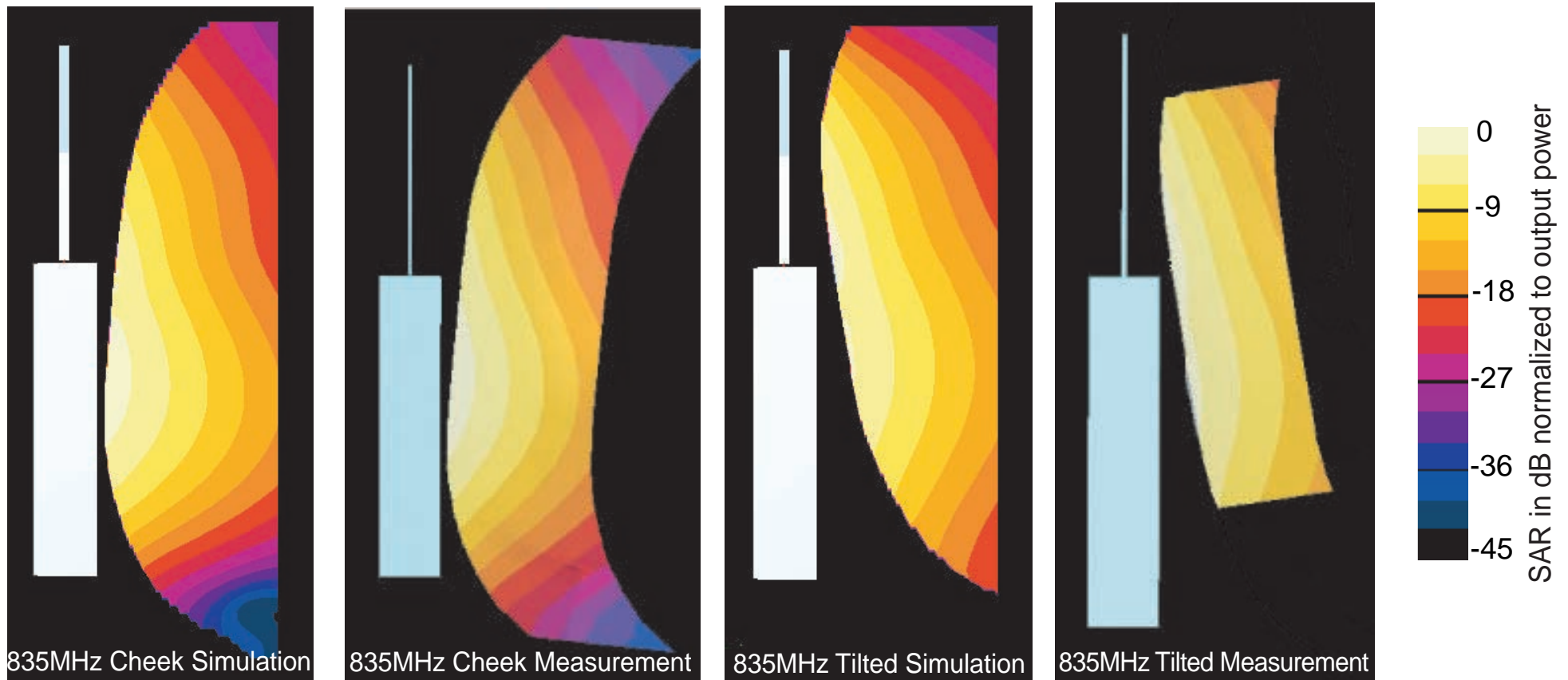

Hypothesis: Age Dependent Dielectric Parameters

- The differences in SAR due to age dependent changes of the dielectric parameters have a larger impact than anatomical variations.

EM Exposure Scenarios

- one adult and three child models with dielectric parameters from Cole-Cole model and age dependent parameters for all age/weight classes
- exposed to the two generic phone models and the Motorola T250
- touch and tilted positions according to [Kainz et al., 2005]
- evaluation of 10g SAR [IEEE C95.3] and av. SAR in brain with and without cerebellum and in brain subregions
- FDTD simulations with Semcad X, nonuniform meshes with step sizes between 0.5mm and 1.5mm in the heads
- approximately 200 different scenarios simulated

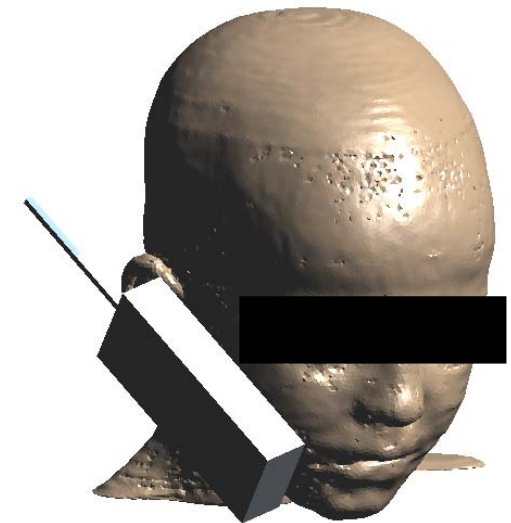

touch position

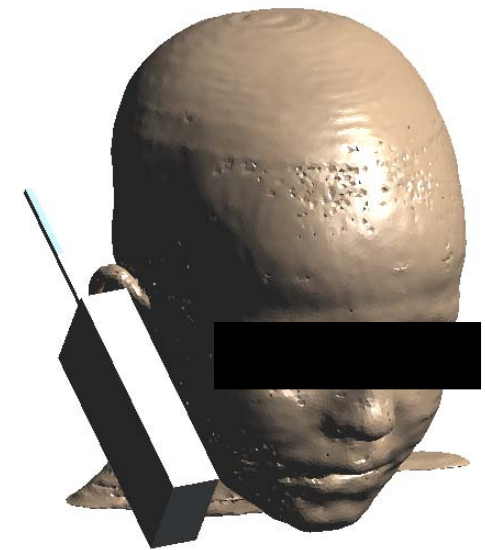

tilted position

Exposure of the Visible Human Head

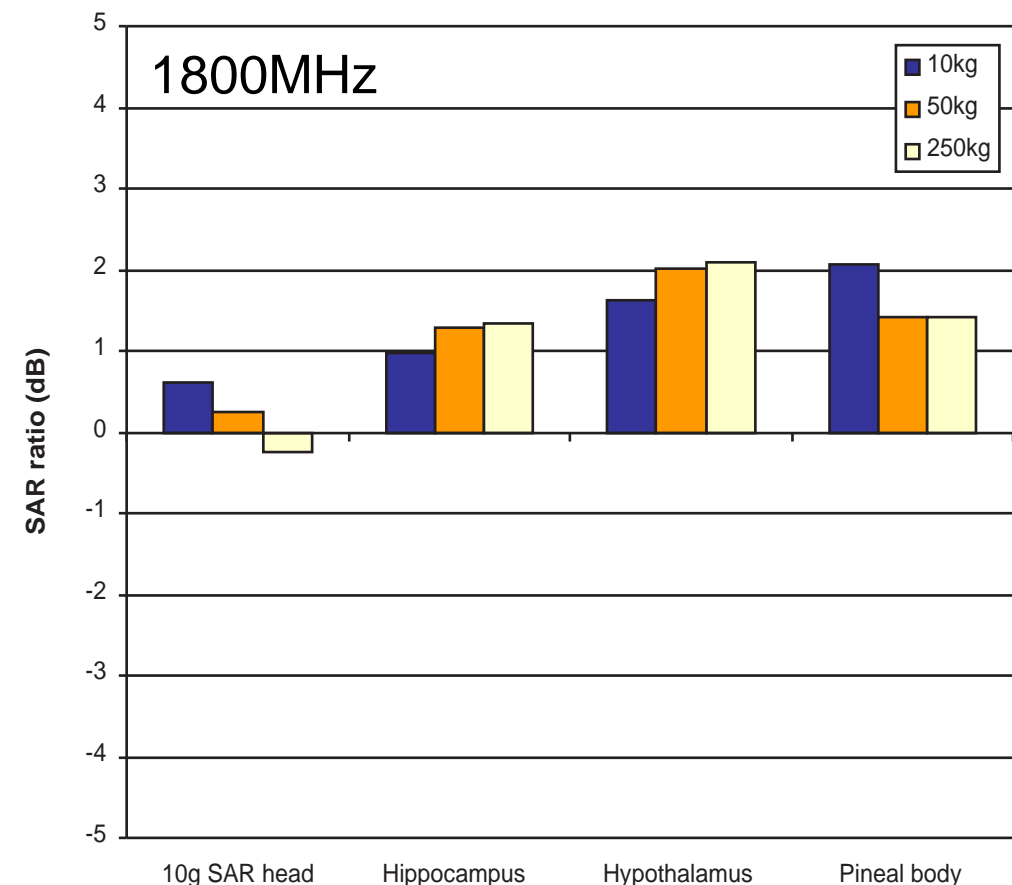
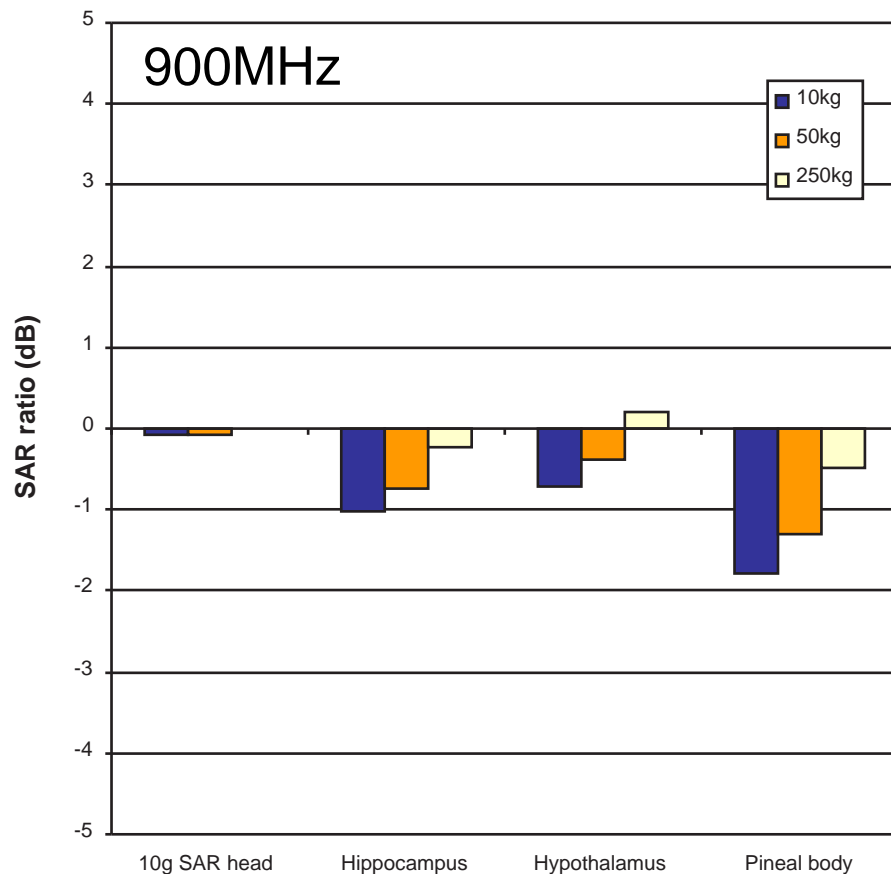

- ratio of the 10g peak spatial av. SAR in the head and brain regions for age dependent parameters in comparison to the Cole-Cole model
- generic phone with monopole antenna, touch position

Exposure of the 11 Year Old Girl

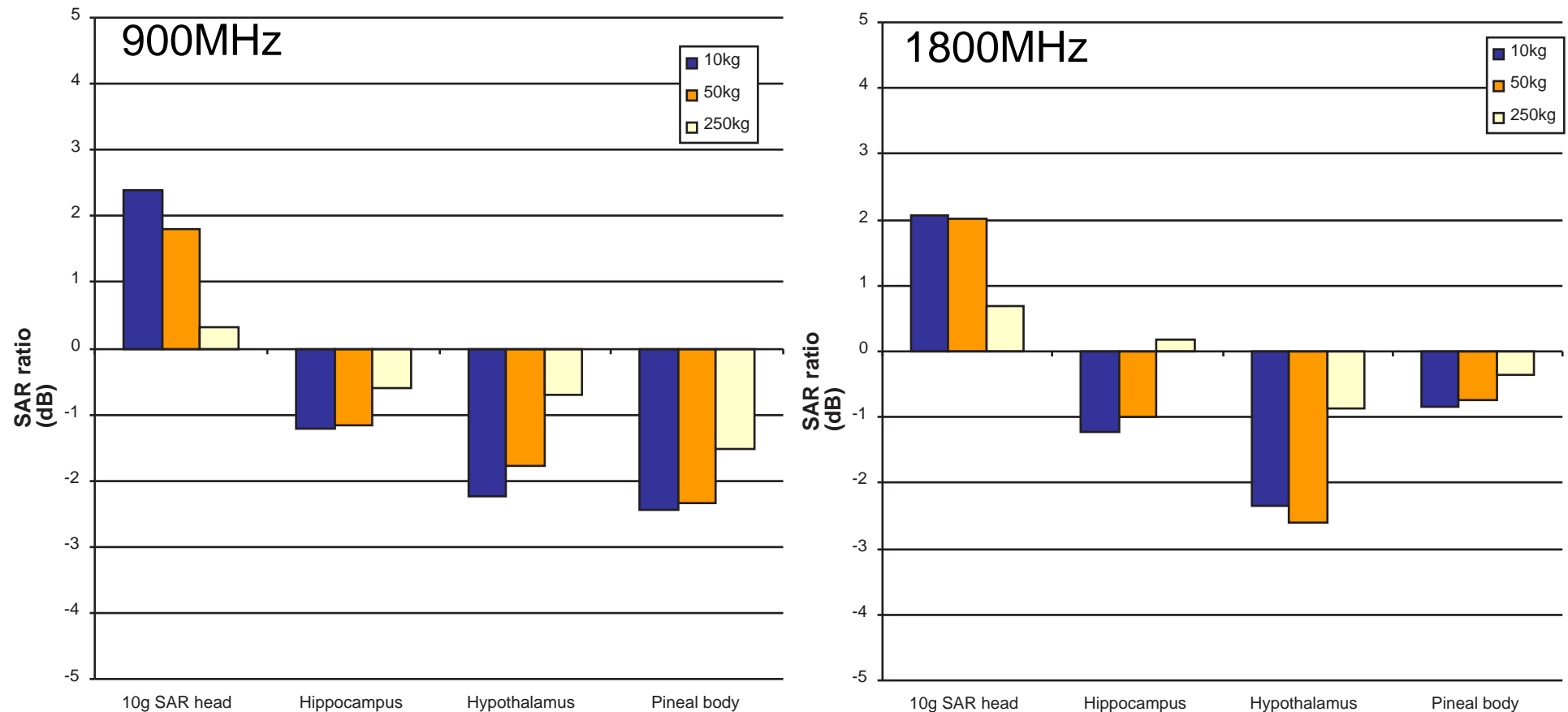

- ratio of the 10g peak spatial av. SAR in the head and brain regions for age dependent parameters in comparison to the Cole-Cole model
- generic phone with monopole antenna, touch position

Exposure of the 6 Year Old Boy

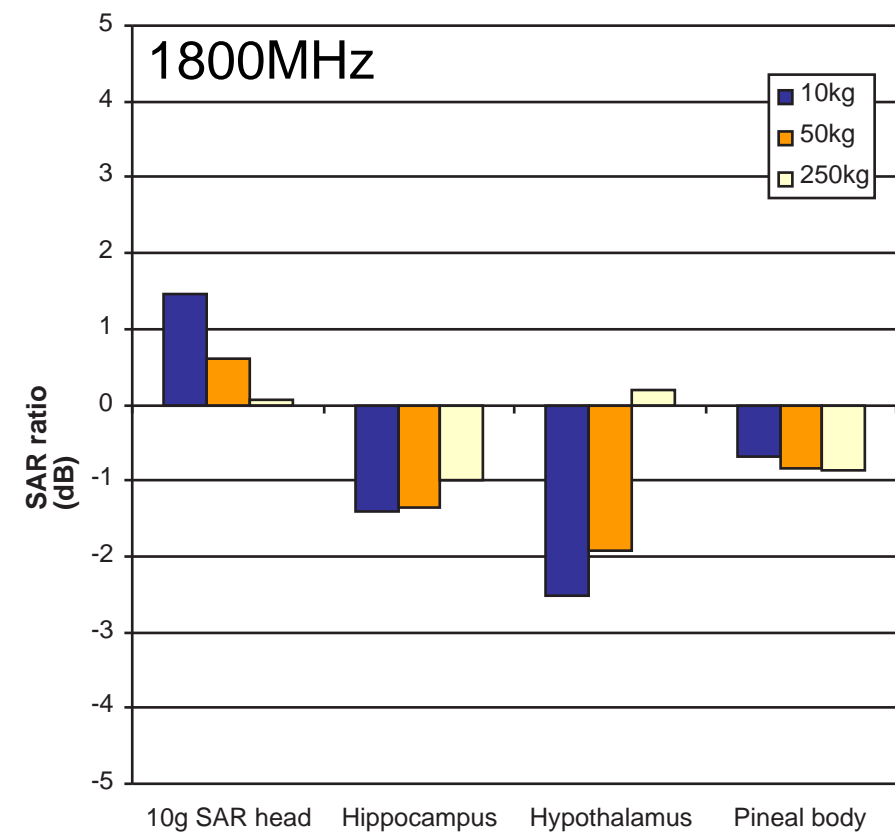
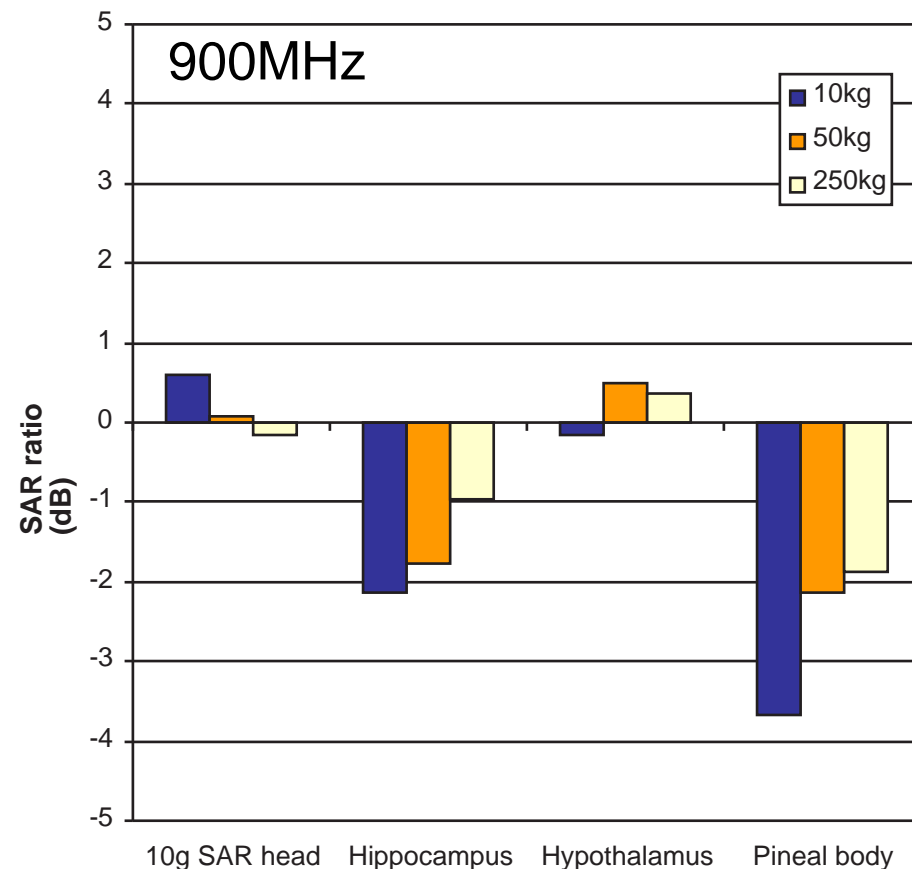

- ratio of the 10g peak spatial av. SAR in the head and brain regions for age dependent parameters in comparison to the Cole-Cole model
- generic phone with monopole antenna, touch position

Exposure of Brain Regions as Function of Head Size

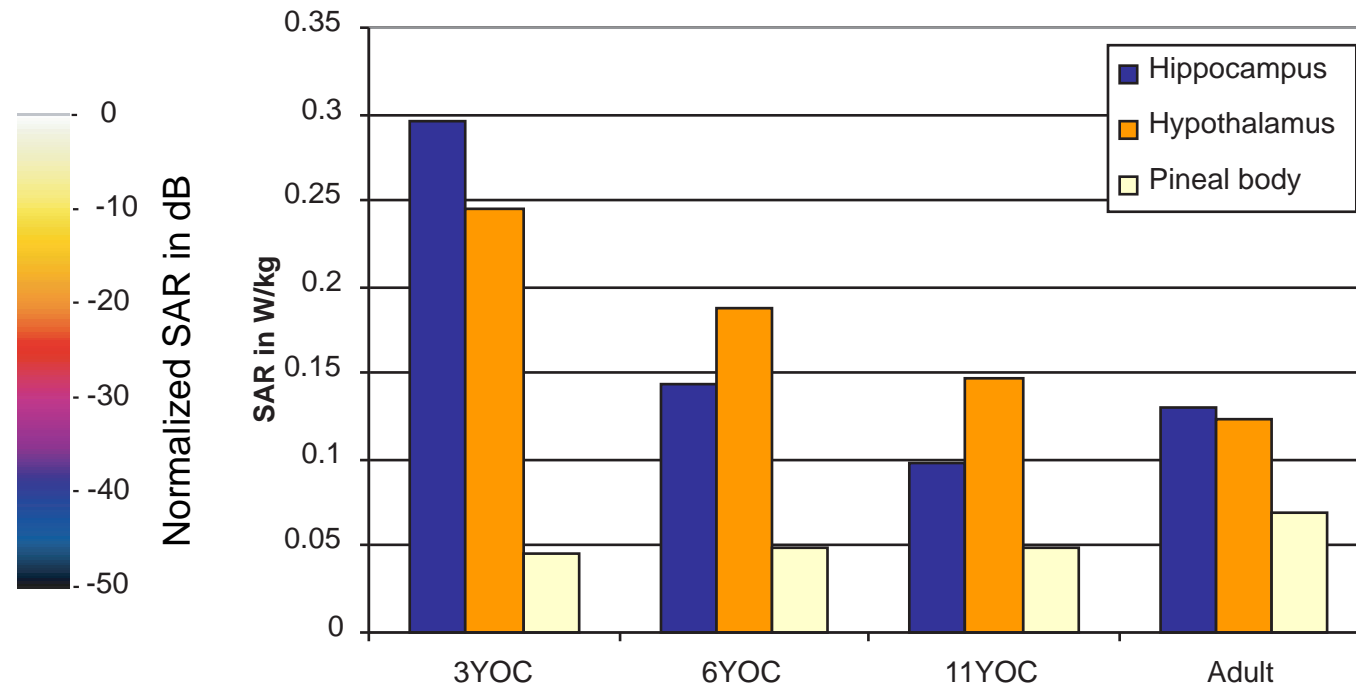
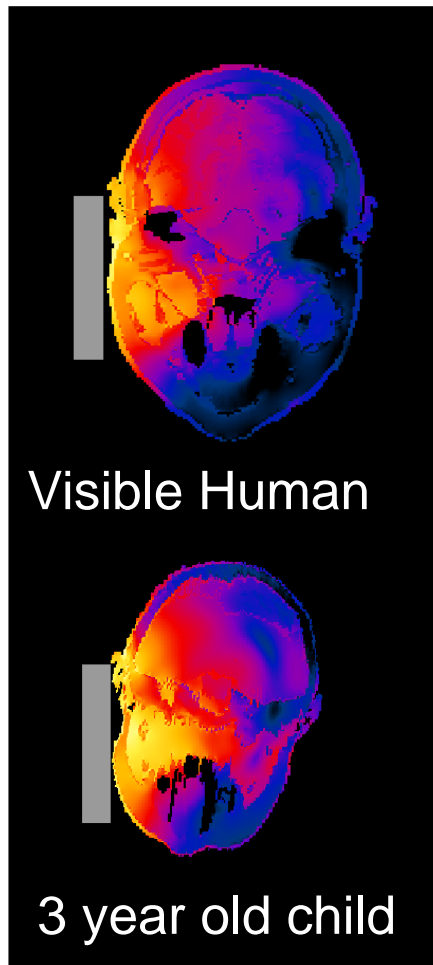

- exposure of different inner brain regions at 900MHz, generic phone with integrated antenna, touch position normalized to 1W antenna power

Exposure of the Brain at 900MHz

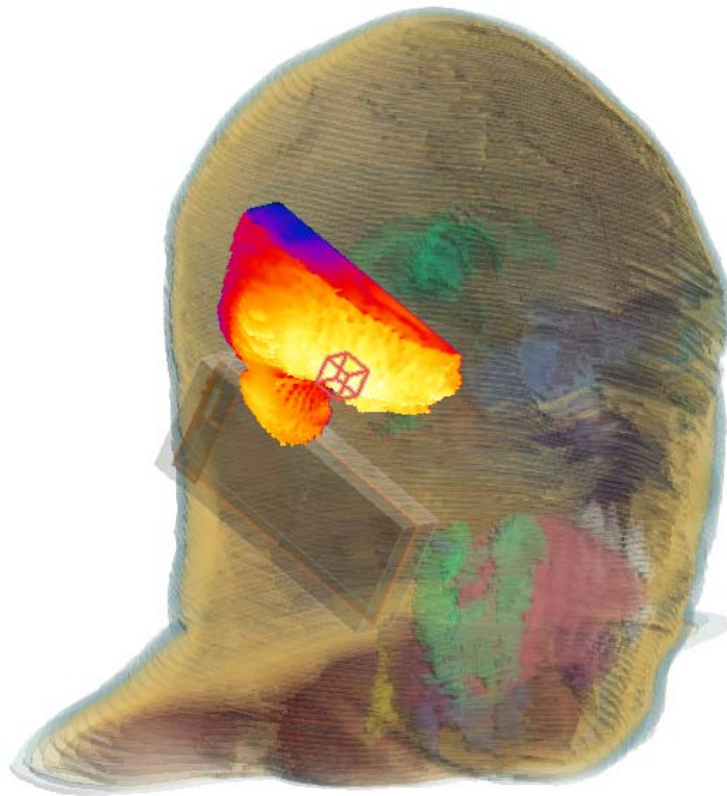

Visible Human

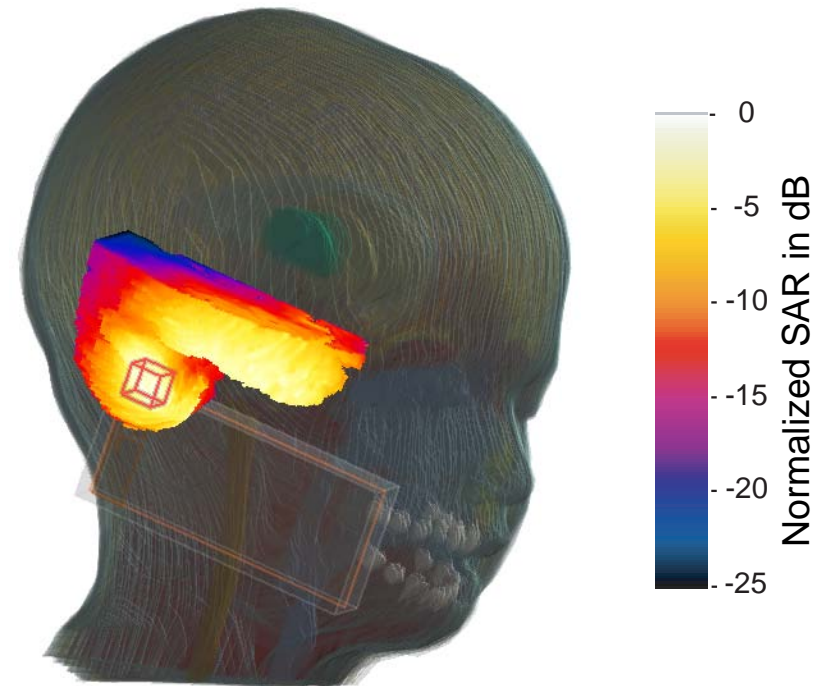

3 Year Old Child

- SAR distribution at 900MHz in brain tissue (grey and white matter, cerebellum)
- cube location at maximum 1g Peak Spatial Average SAR

Exposure of the Brain at 1800MHz

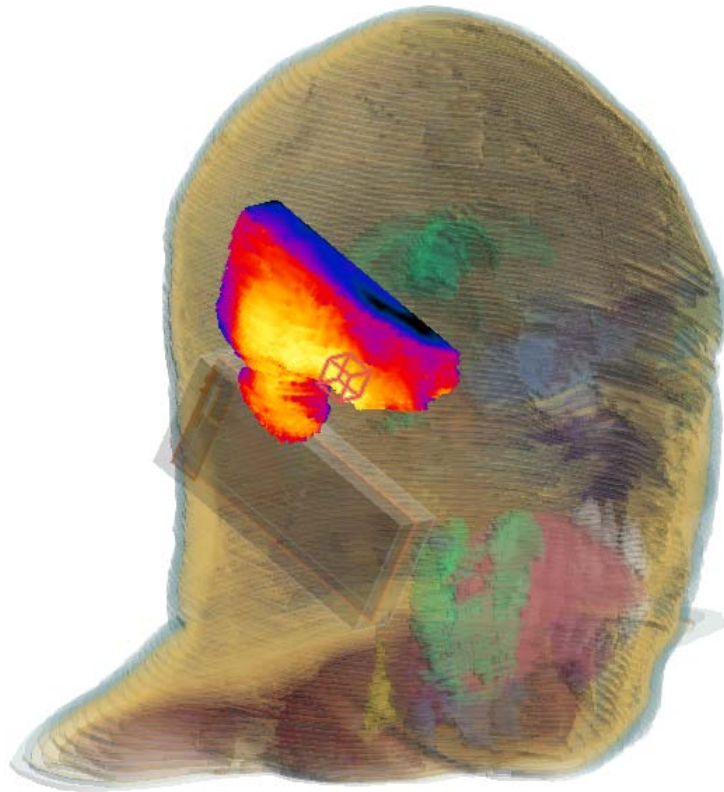

Visible Human

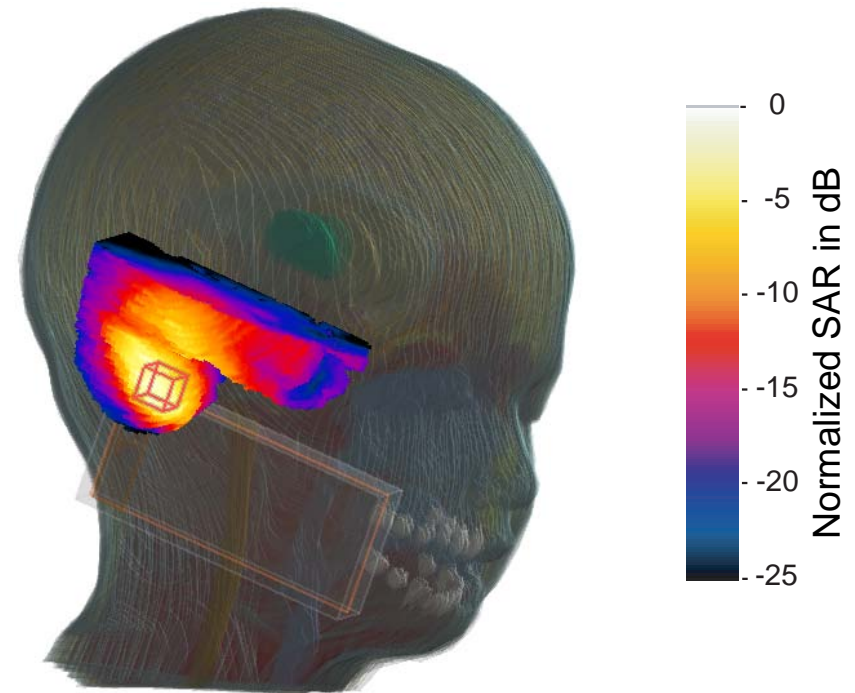

3 Year Old Child

- SAR distribution at 1800MHz in brain tissue
- cube location at maximum 1g Peak Spatial Average SAR

Av. SAR Ratio of the Brain: Child vs. Adult

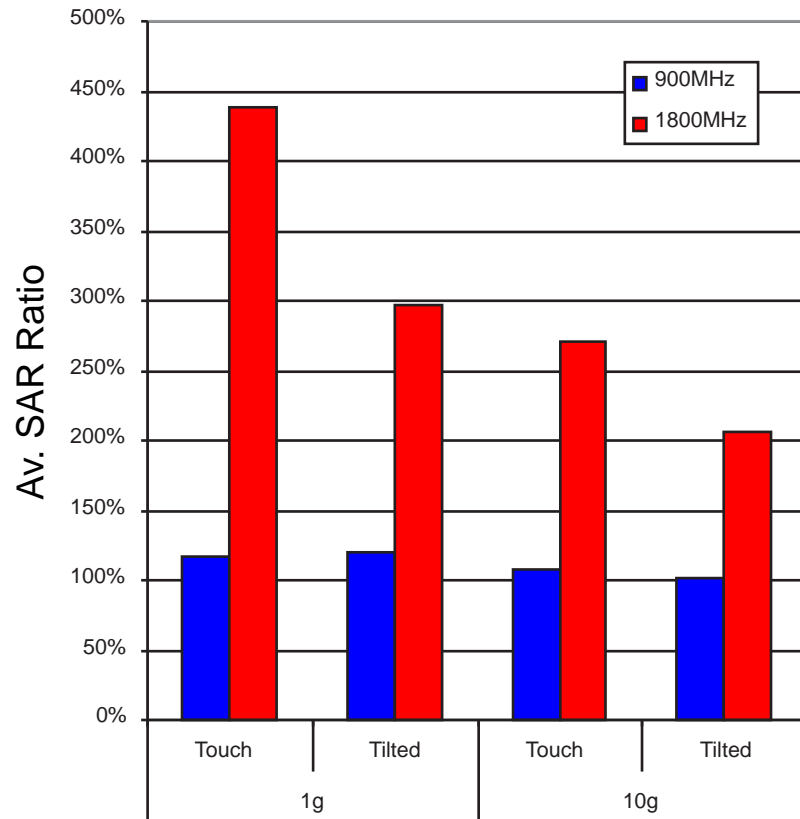

- SAR maximum located in cerebellum of children
- current density maximum of the phone in the center of the ground plane (900MHz) or at the antenna (1800MHz)
- strong increase of SAR in the brain of the 3 year old child because SAR maximum is directly located at current maximum

Thermal Simulations

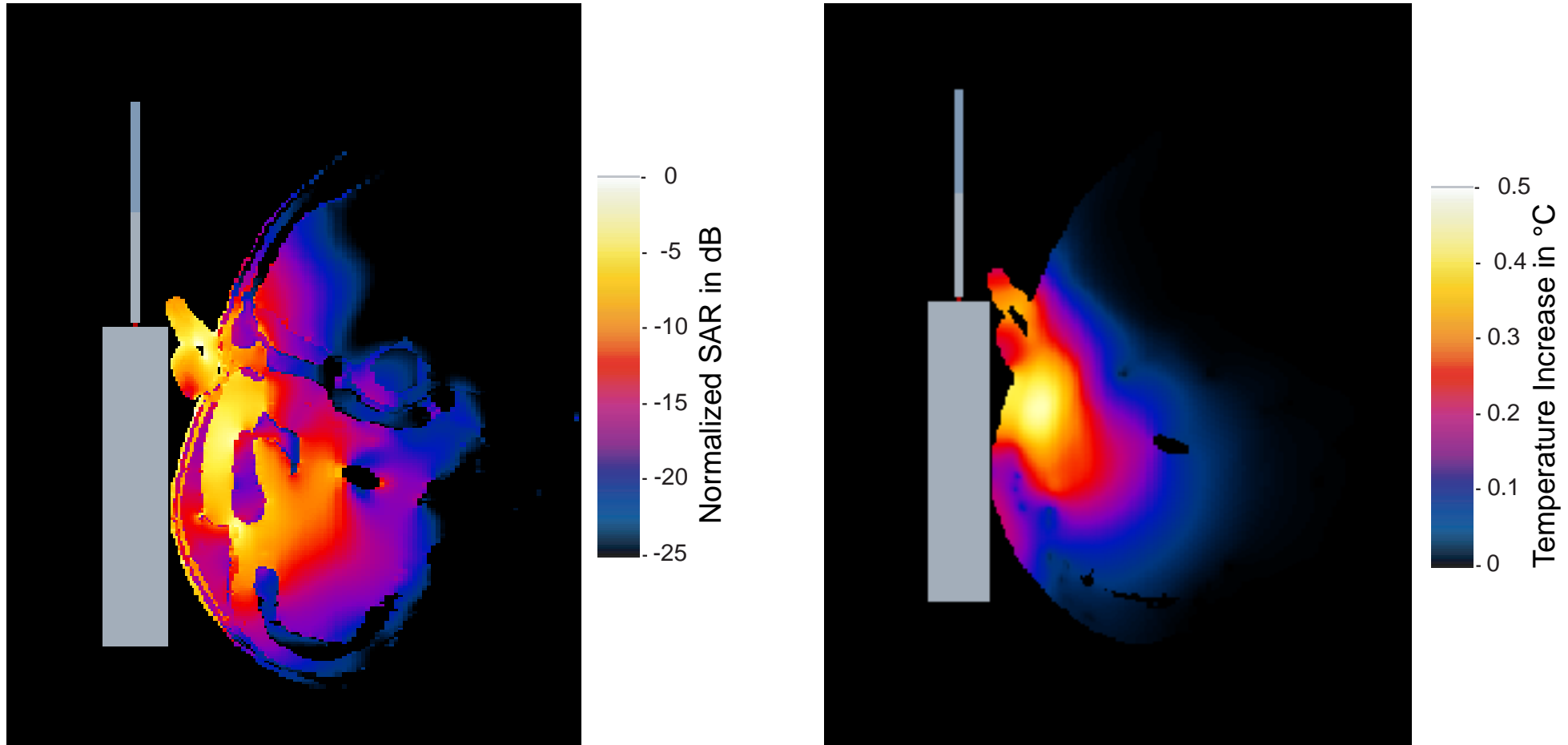

- The assessment of the impact of the uncertainties of the thermal parameters and thermoregulatory effects is ongoing.

Experimental Validation

- temperature measurements in the auditory canal
- exposure protocol
- initial measurement results
- assessment of the pinna dimensions
- experimental phantom of a child head

Hypothesis: Temperature Rise in Adults and Children

- At exposure levels from mobile phones, possible differences in the induced temperature increase between adults and children are in the range of the probe sensitivity limit.
- Procedures providing improved sensitivity are required and are currently under investigation.

Exposure Setup for Temperature Measurements

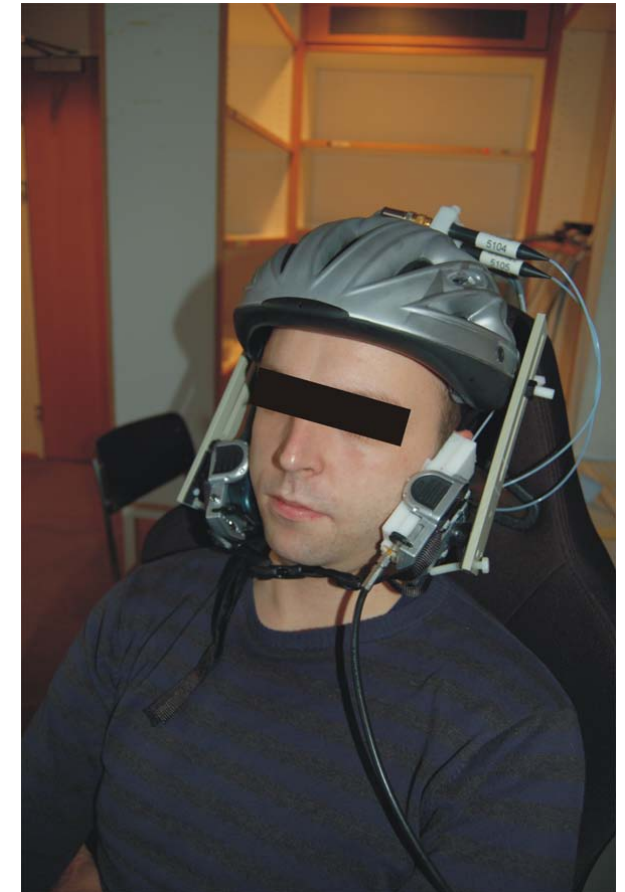
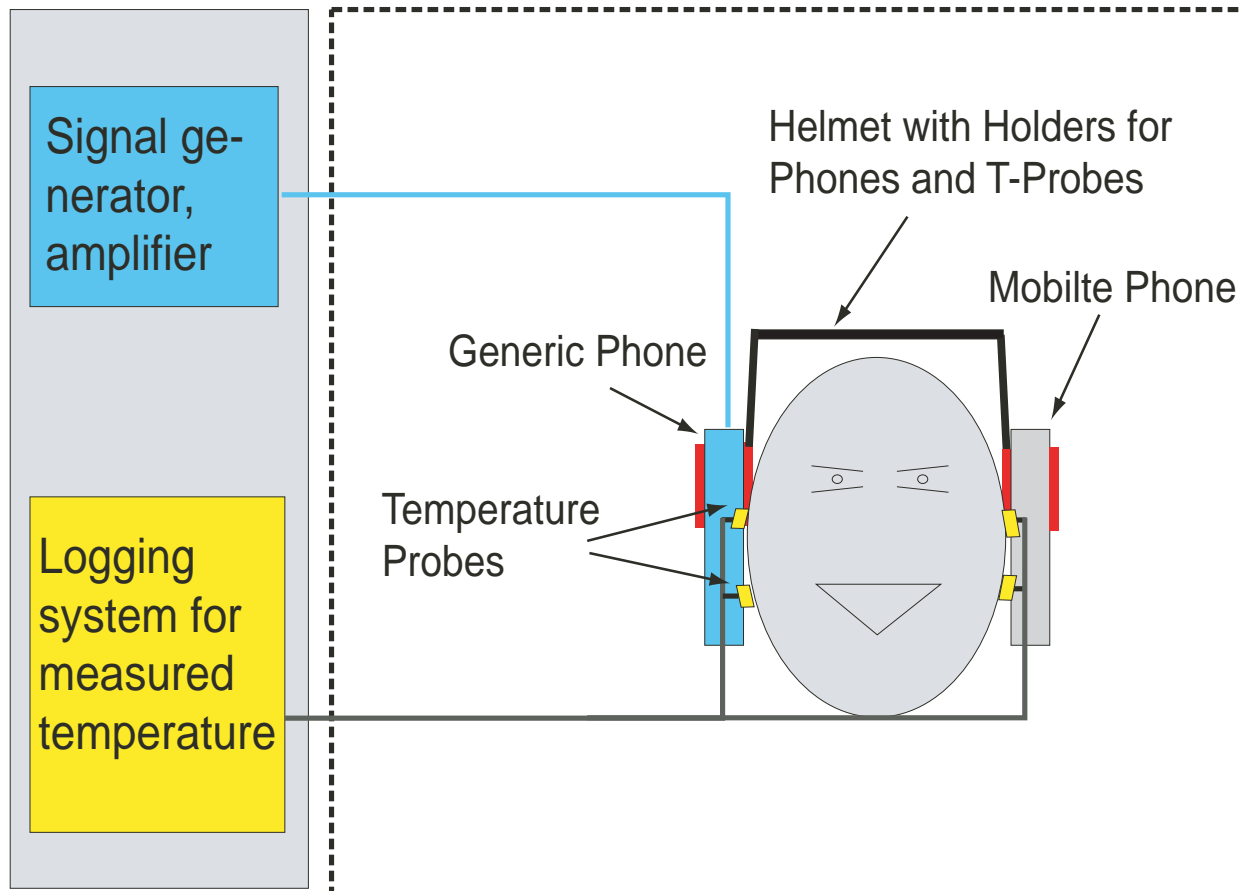

Temperature Probes

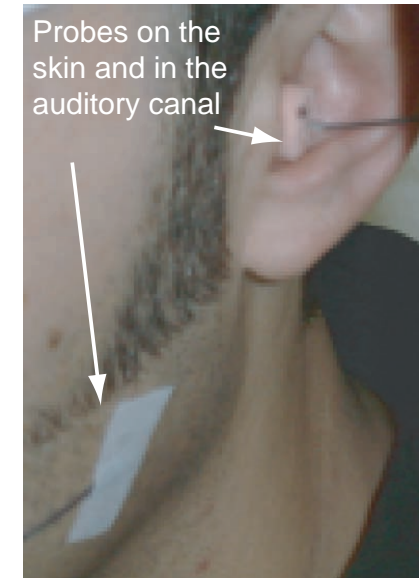
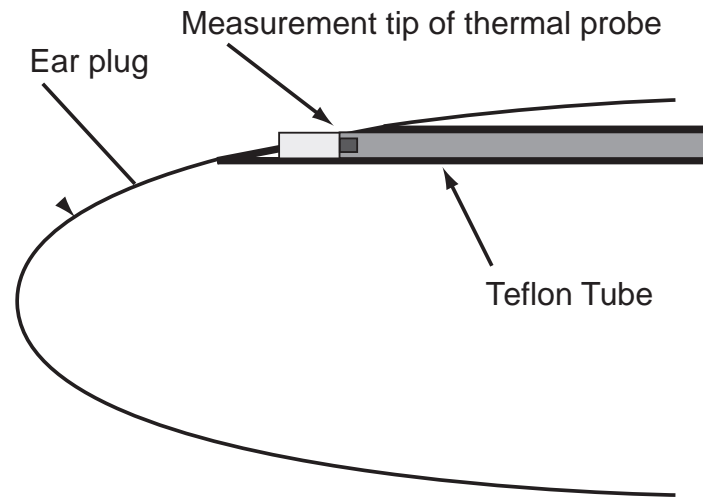
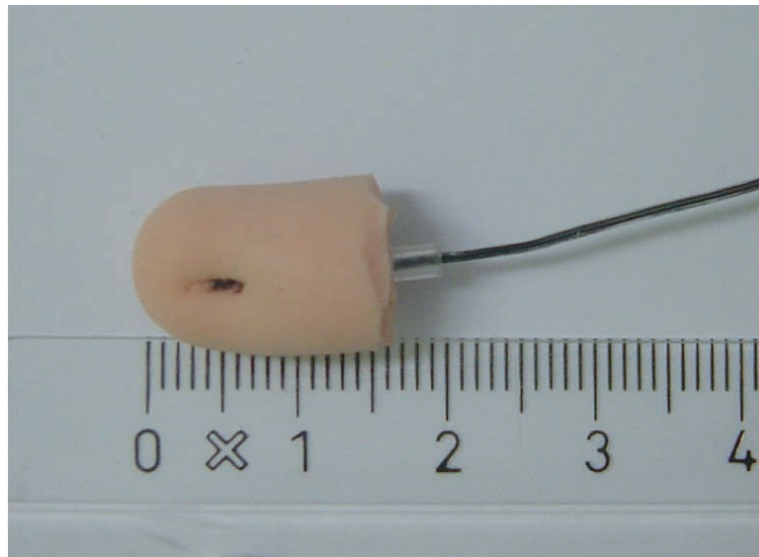

- miniature thermal probe (NTC) with highly resistive lines
- measurement range: 0°C - 60°C
- accuracy ΔT : $\pm 0.01^\circ\text{C}$, dT/dt : $\pm 2\%$, Noise $\pm 0.1\text{mK/s}$ (10s ev. time)
- sensitivity (SAR): 0.2mW/kg
- time constant $< 1\text{s}$
- E-field interference: 0.6mK at 1000V/m on a length of 50mm (parallel E-field), no interference at perpendicular orientation of the E-vector

Exposure Protocol

- approval of the protocol by ethics committee of ETH Zürich
- 16 male adults (20-30 years old) and 16 children (6-10 years old)
- air conditioned room
- introductory talk, measurement of the ear dimensions and body temperature (infrared thermometer)
- mounting of the exposure setup (phones preheated to 37°C), adaptation phase of 30 minutes
- 4 exposure phases of 7.5 minutes:
 - generic phone (2W/kg) right side, sham left side
 - T250 (0.6W/kg) left side, sham right side
 - generic phone (2W/kg) right side, sham left side
 - T250 (0.6W/kg) left side, sham right side
- measurement of the ear temperature with an infrared thermometer

Temperature Rise in SAM at 10 W/kg av. Peak SAR

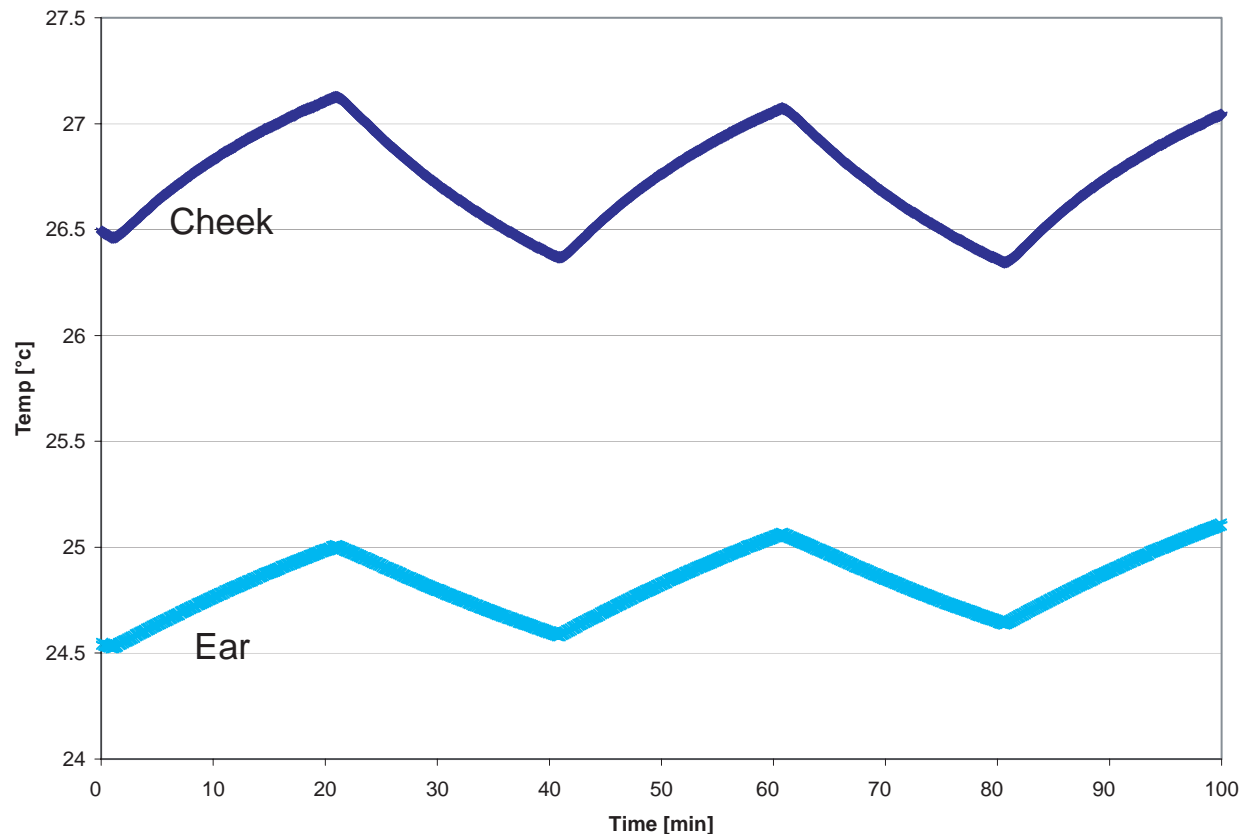

- SAM phantom filled with tissue simulating gel and equipped with temperature probes on the cheek and in the ear

Temperature Rise in Volunteers at 10W/kg

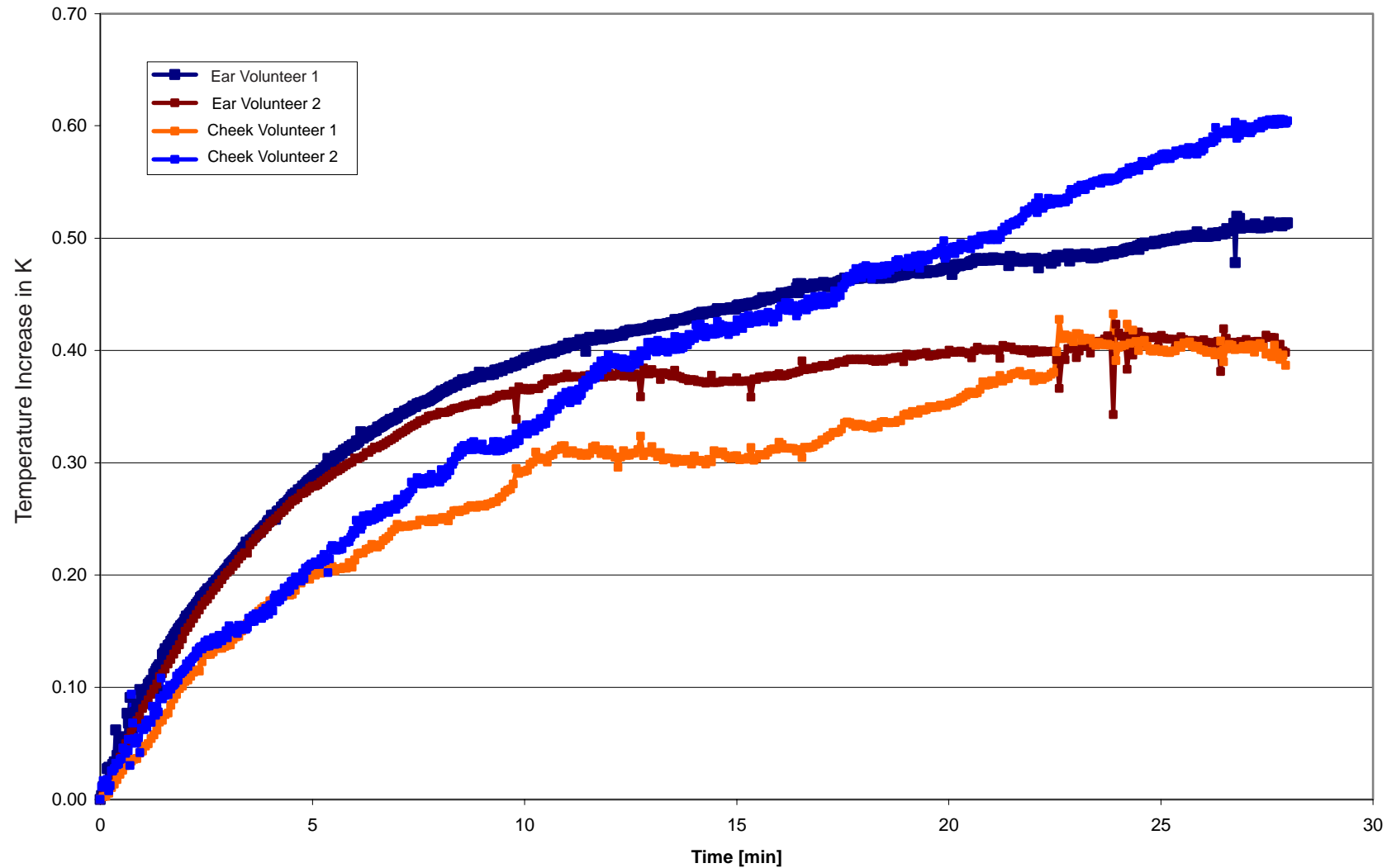

Gauge for the Measurement of the Ear Thickness

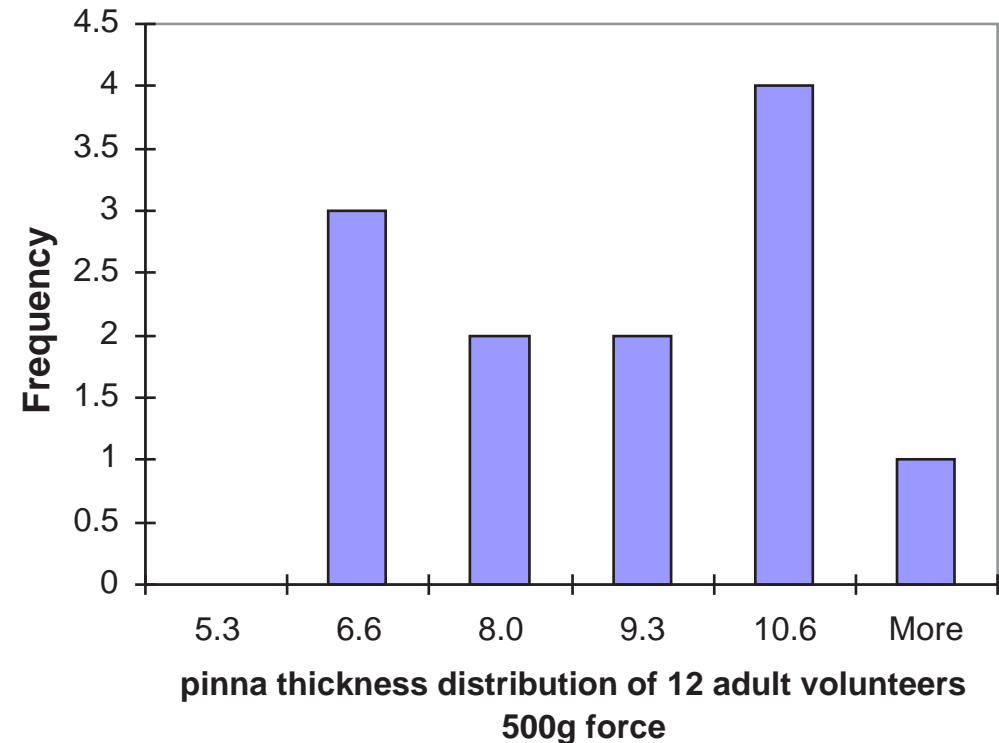
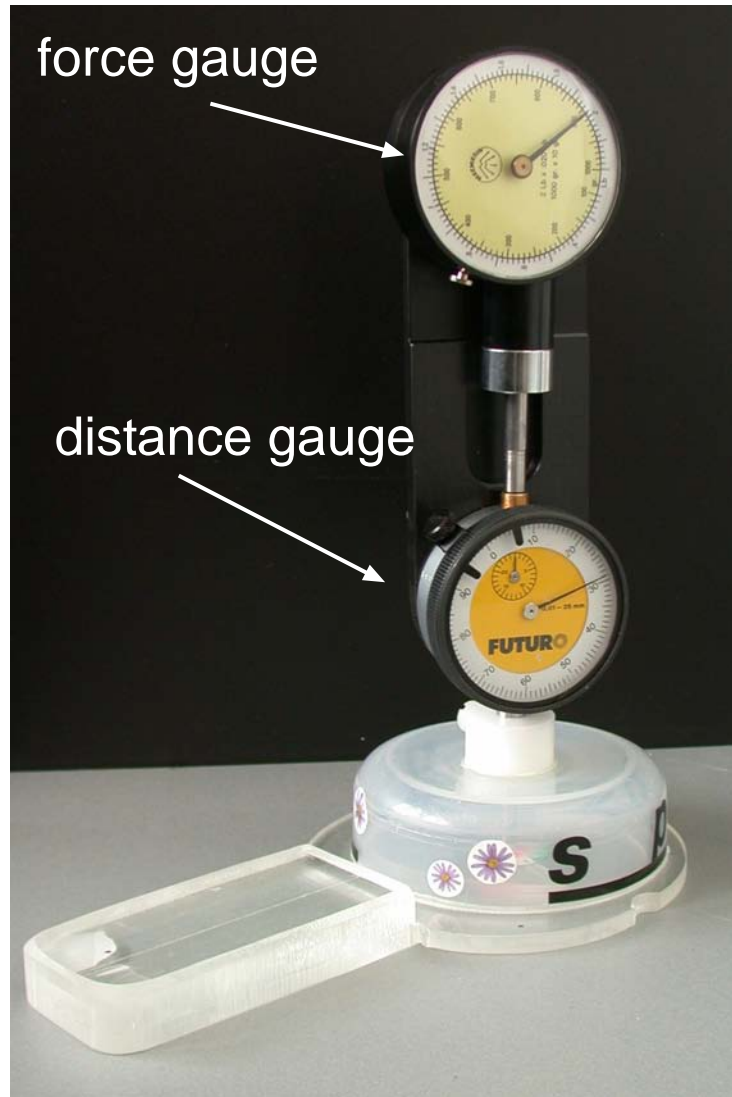

- supporting base of shape and size of a cell phone for natural positioning
- force gauge for control of contact pressure of the pinna
- std. dev. of repeated measurements generally better than 20%

Dosimetric Phantom of a Child's Head



- head phantom of a 3 year old child manufactured from the anatomical model using laser sintering
- surface thickness 2mm

Summary

- head models completed (improved geometrical resolution due to custom made segmentation software)
- SAR simulations completed (approx. 200 configurations x 10 evaluated endpoints)
- interpretation of these values in progress
- pilot temperature simulations show the expected differences to the experimental data (appropriate thermal tissue parameters under evaluation)
- experimental child head phantom close to completion
- in vivo measurement setup constructed and tested (optimization of setup and measurement protocol in progress)
- pinna thickness measurement gauge developed and tested
- ethics committee approval received (much more difficult than expected)
- recruitment of volunteers in progress

Next Steps

- statistical evaluation of SAR evaluations
- conclusion of temperature simulations considering experimental results
- experimental evaluation of child head phantom
- revision of pinna thickness of numerical child models and SAR evaluation
- completion of temperature measurements in adults and children